

# 6 iE<sup>TM</sup> WiFi Thermostat

The smartest, most efficient way to control the world's best selling floor heating

# Pack Contents

---

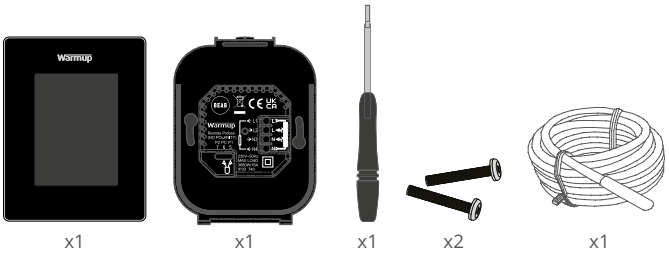

# Contents

---

Safety Information .....	3
Step 1 - Installation .....	3
Step 2 - Wiring Connections .....	4
Wiring Connections - Loads over 16 amps.....	5
Step 3 - Thermostat Mounting .....	6
Step 4 - Initial Setup.....	6
Step 5 - Add Location and Room.....	6
Welcome to the 6iE.....	7
Getting Started .....	7
How to quickly change the temperature .....	7
How to quickly change mode .....	7
Heating.....	8
How to set a program.....	8
Setback Temperature .....	8
How to set into Manual Mode.....	9
How to set into Holiday Mode.....	10
How to switch "Heating Off" .....	10
Energy Monitor.....	11
SmartGeo .....	11
Settings.....	12
Advanced Settings .....	13
Troubleshooting.....	14
WiFi Troubleshooting .....	15
Technical Specifications .....	16
Warranty .....	17
Appendix 1.0 - Thermostat use cases .....	18

## Safety Information

- ❑ The 6iE must be installed by a qualified electrician. It requires a permanent 230 V AC supply from a 30mA RCD or RCBO protected circuit in accordance with the current edition of the BS7671 Wiring Regulations.
- ❑ Isolate the 6iE from the mains supply throughout the installation process. Ensure that wires are fully inserted into the terminals and secured, free strands should be trimmed, as they could cause a short-circuit.
- ❑ Install the 6iE in an area with good ventilation. It should not be beside a window/door, in direct sunlight or above another heat generating device (e.g. radiator or TV).
- ❑ Ensure the distance from your router to the 6iE is not excessive. This will ensure the wireless connection is not subject to range issues once installed.
- ❑ For bathroom installations the 6iE MUST be mounted outside of Zones 0, 1 and 2. If this is not possible then must be installed in an adjacent room, controlling the rooms using remote sensor(s).
- ❑ The 6iE and its packaging are not toys; do not allow children to play with them. Small components and packaging present a risk of choking or suffocation.
- ❑ The 6iE is suitable for indoor use only. It must not be exposed to moisture, vibrations, mechanical loads or temperatures outside of its rated values.
- ❑ For safety and licensing reasons (CE/UKCA), unauthorised change and/or modification of the 6iE is not permitted.

## Step 1 - Installation

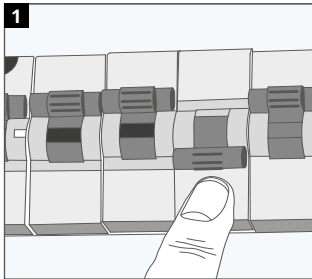

1  
Isolate the 6iE supply from the mains supply.

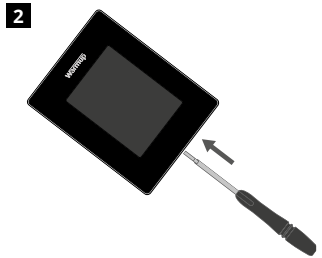

2  
Unclip the display from the power base.

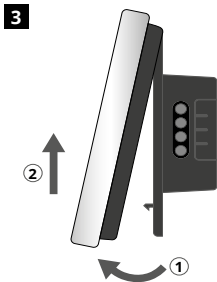

3  
Release the display as shown.

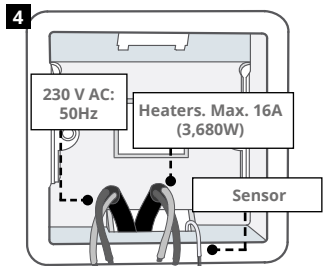

4  
Install a 50 mm deep electrical back box in your preferred thermostat location. Pull wires (heater, supply and sensor(s)) through back box and complete terminal wiring.

## Step 2 - Wiring Connections

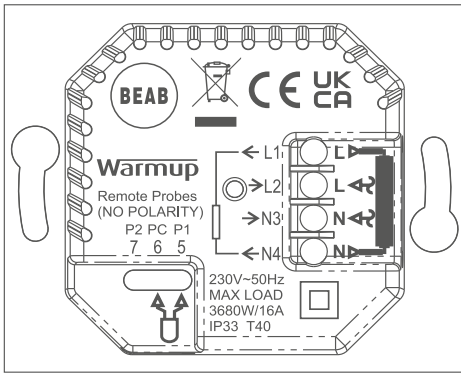

### WARNING!

The 6iE must be installed by a qualified electrician in accordance with the current edition of the BS7671 Wiring Regulations. Wire the 6iE using the diagram above and heater type wiring information below.

**NOTE:** For loads above 10 A, the conductor wire gage should be at least 2.5mm<sup>2</sup>

### ELECTRIC UNDERFLOOR HEATING

- L1 & N4** Heater Live and Neutral Max. 16A (3680W)
- L2 & N3** Supply Live and Neutral
- 5 & 6\*** Floor Sensor (No Polarity)

### HYDRONIC UNDERFLOOR HEATING

- L1** Switched Live to Wiring Centre
- L2 & N3** Supply Live and Neutral
- N4** Not Used
- 5 & 6\*** Floor Sensor (No Polarity)

- Floor sensor connection;

- 5 & 6** Scheduled floor temperature with air limit
- 6 & 7** Scheduled air temperature with floor limit

*Refer to Appendix 1.0 for alternative thermostat use cases*

### CENTRAL HEATING

- L1** Switched Live to Zone Valve/Boiler
- L2 & N3** Supply Live and Neutral
- N4** Not Used
- 5 & 6** Not Used

For extra low voltage or volt-free systems a contactor must be used. Connecting the 6iE directly to extra low voltage or volt-free boilers may cause damage to the boiler circuit.

## Step 2 - Wiring Connections - Loads over 16 amps

Warmup thermostats are rated for a maximum of 16 amps (3680 W). A contactor must be used to switch loads exceeding 16 amps. Please see wiring diagram below.

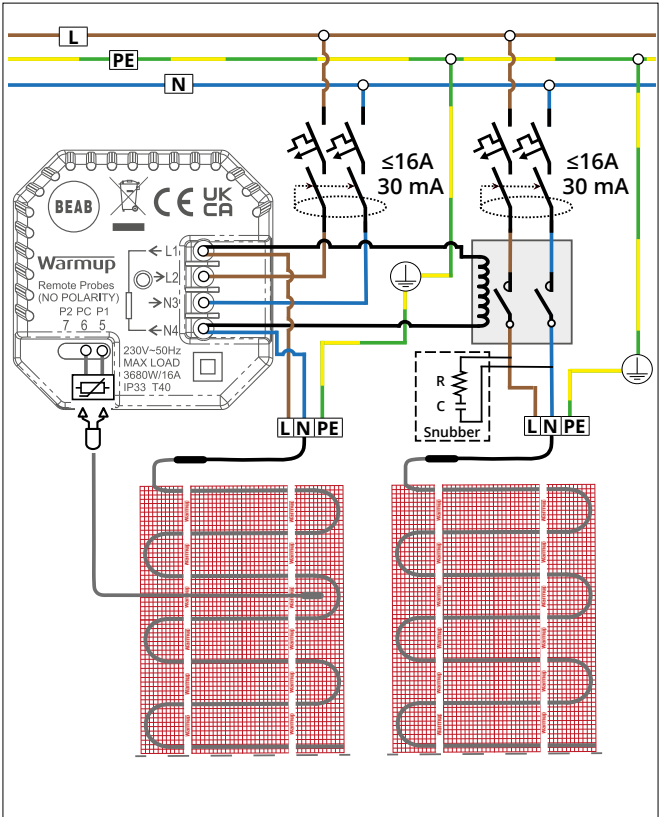

## Step 3 - Thermostat Mounting

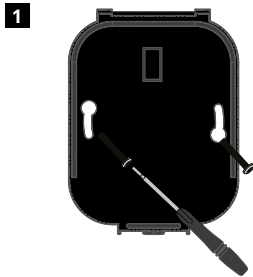

Insert fixing screws through mounting holes of the power base and tighten.



Re-attach the display until a “click” is heard. You can now restore power to the circuit and power up the thermostat. Follow the on screen instructions to set up your system. Once set up a QR Code will appear.

## Step 4 - Initial Setup



Download the MyHeating App.



Open the My Heating App and scan the QR Code on the 6iE screen. Follow the instructions in the App to complete setup.

## Step 5 - Add Location and Room

The MyHeating App will guide you through the setup of your 6iE. You will have to set up your house location and then the room within which your new 6iE is located.



### Location

A location needs to be setup before a room can be configured and the 6iE device registered. Creating a location is user friendly and easy to follow, it is advised to have details of your current energy tariff and pricing to hand, as these will be required if you wish to use the energy monitoring features.



### Room Setup

With a location now setup, the next step is to register a room in which your 6iE is located. This is the heating zone your thermostat will control. Ensure you set the correct System Type and Wattage of heaters connected.

**NOTE:** If an external relay or contactor relay has been installed please set System Type as Electric + Relay.

## Welcome to the 6iE



**Heating Indicator**  
Displays when heating is active

**Error Messages**  
See Troubleshooting Page

**Current Floor/Air temperature**  
Floor will be displayed if floor sensor is installed and switched on

**Temporary Override**  
Use the slider or press the +/- icons to set a temporary override until next heating period

**Target Temperature**  
Temperature you wish the thermostat to achieve

**Weather**  
7-day forecast for your area

**Menu**

**Air limit**  
Will only be displayed when in floor mode and an air limit is set. See Appendix 1.0 for alternative thermostat use cases

## Getting Started

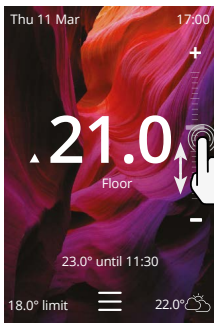

### How to quickly change the temperature

Use the slider or press the +/- icons to change your target temperature.

If in **"Program"** mode this will set a temporary override until your next heating period.

If in **"Manual"** mode this will set a fixed target temperature.

Once the target temperature is set above current floor/air temperature the heating indicator will appear.

### How to quickly change mode

Mode select allows you to quickly change from program, manual or holiday modes. You can also switch **"Frost Protection"** on or simply switch the **"Heating Off"** from here. Frost protection will ensure that the floor/air temperature does not drop below 7.0°.

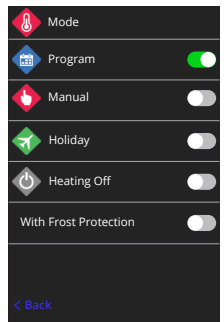
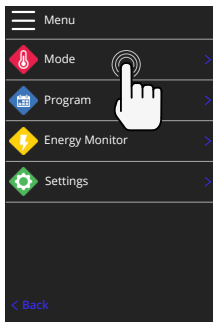
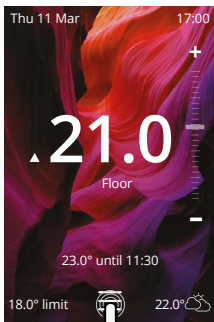

# Heating

## How to set a program

Setting a "Program" allows you to set comfort temperatures at set times throughout the day. Days can be programmed individually, all days the same or weekdays as a block and weekends as a block, the choice is yours.

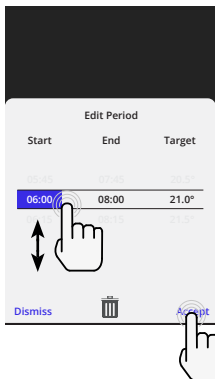
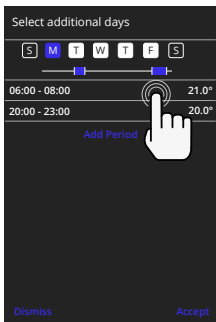
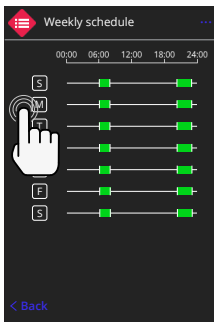
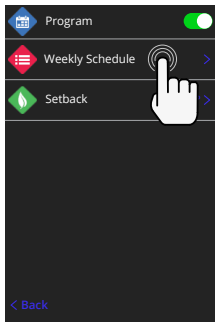
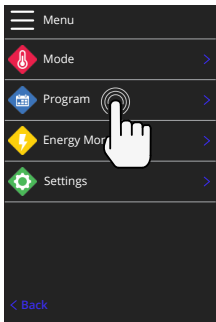
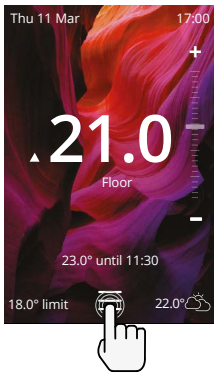

To "Select additional days" press the days of the week and the squares will be highlighted in white as shown and will follow the programmed heating schedule.

Once you are happy press "Accept" to save the heating schedule.

**NOTE:** For tailor-made preset heating schedules for different room types press the three dots "...".

## Setback Temperature

The "Setback" temperature is a lower energy efficient temperature when outside of a heating period.

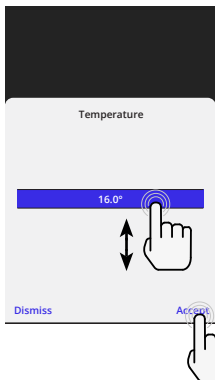
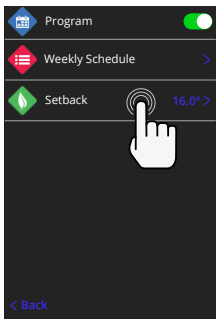



# Heating

## How to set into Manual Mode

Setting into *“Manual”* mode allows you to set a fixed target temperature for the thermostat to achieve. The thermostat will continue to maintain this temperature until another operating mode or temperature is selected.

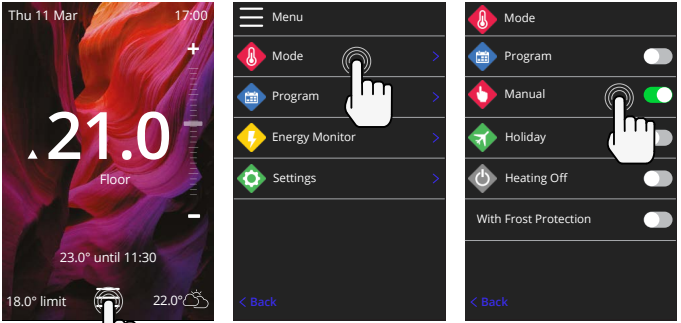

# Heating

## How to set into Holiday Mode

"Holiday Mode" allows you to override your schedule with a lower fixed temperature over a set time to save energy.

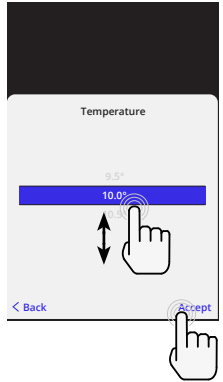
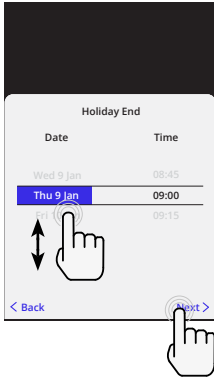
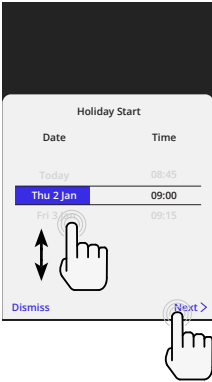
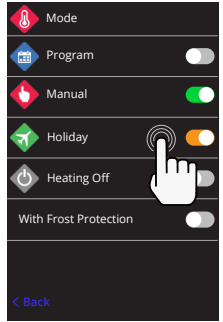
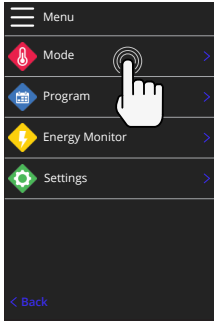
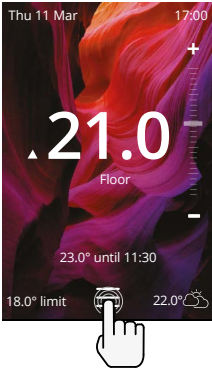

## How to switch "Heating Off"

This will switch the heating off until you cancel it by pressing "Heating Off" on the homescreen or going into mode select and pressing the "Heating Off" slider.

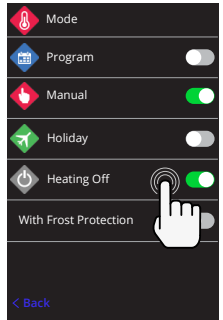
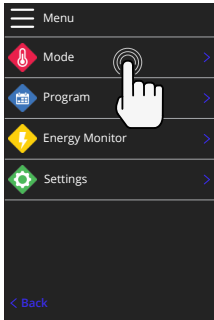
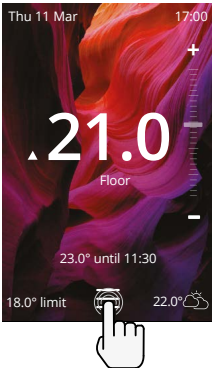

## Energy Monitor



Energy Usage

Last 24 Hours	1.5kWh
Last 7 Days	0.0kWh
Last 30 Days	0.0kWh
Since reset	0.0kWh

[Reset record](#)

[Back](#)

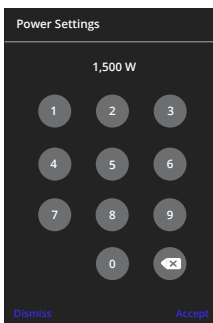

Power Settings

1,500 W

1	2	3
4	5	6
7	8	9
0	<a href="#">X</a>	

[Dismiss](#) [Accept](#)

### How Energy Monitor works

The 6iE learns how you use your system and how your house reacts to heating and weather. Energy monitoring will show the amount of energy consumed over a certain time period. This will be calculated through system power multiplied by efficiency and run time.

You will need to enter the power of your system, and in some cases, the efficiency.

If you do not know these, speak to your installer or system manufacturer.

### Changing the Power Settings

If you have entered the wrong system power during setup it can be changed in Energy Monitor; Power Settings.

## SmartGeo

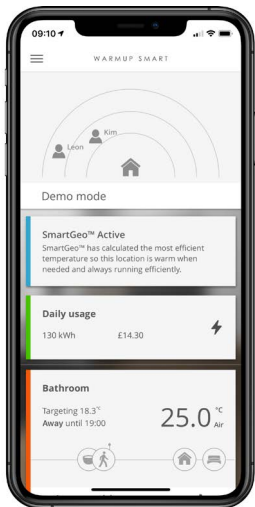

### How SmartGeo works

SmartGeo is a unique technology developed by Warmup and built into the MyHeating App that uses an advanced algorithm to understand the most efficient heat settings for your home.

Working automatically; it learns your routines and location through background communication with your smartphone and lowers temperatures when you are away, only rising them up to your ideal comfort temperature in time for your arrival home.

Smartgeo will operate when the thermostat is in the program or manual run modes. It is turned off by default. Use the MyHeating App to switch SmartGeo on.

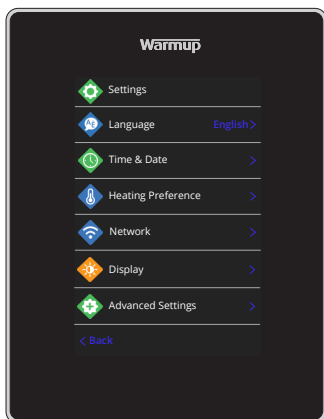

<b>Language Settings</b>	Change the 6iE language	
<b>Time &amp; Date</b>	Change the Time and Date	
	Daylight savings	On/Off
	24-hour time	On/Off
<b>Heating Preference</b>	Temperature unit	°C/°F
	Open window detection	On/Off
	<i>The windows open detection feature is designed to switch off heating to save energy when the thermostat detects that a window or door has been opened and, the outside air temperature is significantly below the indoor temperature.</i>	
	Adaptive Learning	On/Off
	<i>Adaptive learning will use the historic heating/cooling rates for the time of day, historic external temperatures and the forecast external temperatures, to work out the heating start time in order to reach the comfort time at the start of the comfort period. It will only work in Program Mode.</i>	
<b>Network</b>	WiFi Connection	On/Off
	<i>It is possible to set a new WiFi connection from here. The current network connection can also be viewed from this menu, including the signal strength.</i>	
<b>Display</b>	Background	Light Dark Random
	<i>Choose the background image of the 6iE. Random is an image selected from Warmup's collection.</i>	
	Standby style	Temperature Time Minimalist
	<i>Choose what will be displayed when the 6iE goes into standby. Temperature will display current temperature; Time will display the current time; Minimalist will show neither.</i>	
	Brightness	Active Standby Night
	<i>Adjust the brightness of the 6iE screen when in Active, Standby or Night Mode.</i>	

## Settings

Display, cont'd	Night period	Set the <b>Start</b> and <b>End</b> period
	<i>This is the time when you usually go to bed at night and wake up in the morning. The brightness of "Night" mode will begin and end using this time.</i>	
	Screen lock	<b>On/Off</b>
	<i>Locks the 6iE screen to prevent any unauthorised changes to the 6iE. Requires a 4 digit code to access the menu or make changes.</i>	

## Advanced Settings

Advanced settings	Sensors & Application	Internal Air Sensor	<b>Offset</b> +/- 10°	
		Probe 1 Connected	<b>On/Off</b>	
			<b>Type</b> 5, 10, 15, 100K <b>Offset</b> +/- 10°	
		<i>The 6iE uses a 10K sensor. However, if using a 6iE to replace an existing thermostat you must change to the correct sensor type.</i>		
		Probe 2 Connected	<b>On/Off</b>	
			<b>Type</b> 5, 10, 15, 100K <b>Offset</b> +/- 10°	
		<i>If a 2nd sensor is wired into terminals 6 &amp; 7 it must be switched on here to act as a limit sensor.</i>		
		Floor thermostat (Probe 1 On, Probe 2 Off. See Appendix 1.0 for alternative thermostat use cases)	<b>Control</b> Floor Remote Air Regulator <b>Limit</b> None/Air	
		<i>Choose to switch the method of control for the sensor; floor sensor, remote air sensor if not installed underneath the floor or regulator mode.</i>		
		<i>Regulator Mode; Heating is on for X% out of control cycle (default 10mins). Heating is off for remaining time.</i>		
		Floor type*	<b>Tile/Stone</b> <b>Laminate</b> <b>Carpet</b> <b>Wood</b> <b>Vinyl</b> <b>Other</b>	
		<i>Choose the floor type of your installation. This will apply different temperature and overheat limits to the 6iE. * Not applicable if conventional heating system was selected.</i>		

## Advanced Settings

Advanced settings	Temperature limits	Set <b>Min./Max.</b> settable temperature limits
	Overheat limit	Set <b>Overheat air</b> limit if floor sensor has been installed
	Control Period	Set between <b>10 - 60 mins.</b>
	<i>Control period checks the difference in the current measured temperature and the set temperature in a proportional integral algorithm to maintain a steady temperature.</i>	
	About	Details about the 6iE's current firmware, MAC address and WiFi connection information.

## Troubleshooting

Display is blank	Brightness	1. Check that the standby brightness is not set to Off.
	Power	2. <b>(Electrician Required)</b> Electrician required to verify power is going to the 6iE and that it is correctly wired.
ER1	Sensor Error	<p><b>(Electrician Required)</b> Electrician required to verify that the floor sensor has been wired correctly. If it is correctly wired the electrician will need to check the resistance of the floor sensor using a multi meter. For temperatures between 20°C - 30°C the resistance of the floor sensor should measure between 8K ohms and 12K ohms.</p> <p>If the electrician finds a fault, and the 6iE is in the room to be heated then it can be set into "Air Mode".</p> <p>To set into "Air Mode", go to Sensors &amp; Application in Advanced Settings and switch the probe off.</p>
Heating is coming on earlier than programmed times	Adaptive learning On	Adaptive learning will use the historic heating/cooling rates for the time of day, historic external temperatures and the forecast external temperatures, to work out the heating start time in order to reach the comfort time at the start of the comfort period. It will only work in Program Mode.
Cannot to set above a certain temperature	Floor Type Temperature Limits	Delicate floor coverings need to have their temperatures limited. If the finished floor is set for wood, laminate, vinyl etc. you are unable to set the temperature above 27°C.
WiFi Error Symbol	WiFi not setup	If you have not done so, download the MyHeating App, go to Settings and Network setup and follow the on screen instructions to connect to a WiFi Network.
	WiFi disconnected	<p>Follow the step above to try and to re-connect to the WiFi Network.</p> <p>If the 6iE still fails to connect, see WiFi Troubleshooting.</p>
Clock Sync Icon	Time and Date not set	Connect the 6iE to a WiFi network or alternatively set the time and date from the settings menu.

## WiFi Troubleshooting

Before following the troubleshooting guide below please check the following:

1. The password is WPA2 protected.
2. The router is set to a 2.4 GHz band. (802.11 b, g, n, b/g mixed, b/g/n mixed)

**NOTE:** If you need to change any of the items listed above, please refer to your router manual.

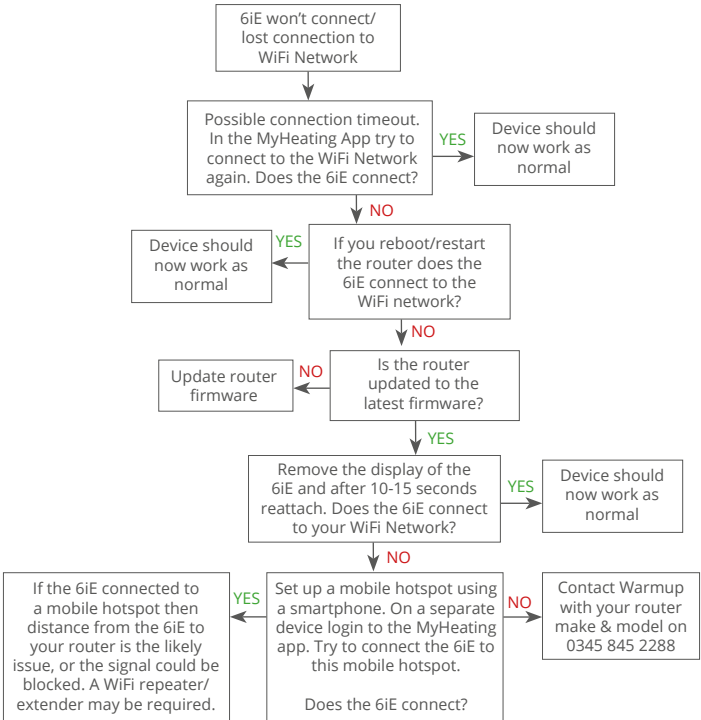

## Technical Specifications

Model	6iE-01-XX-YY
Operating Voltage	230 V AC : 50 Hz
Protection Class	Class II 
Max. Load	16A (3680W)
Rated impulse voltage	4000V
Automatic action	100,000 cycles
Disconnection means	Type 1B
Pollution degree	2
Max. Ambient Temperature	0 - 40°C
Relative Humidity	80%
IP Rating	IP33
Dimensions (Assembled 6iE)	90 x 115 x 39 mm
Screen size	3.5in
Sensors	Air & Floor (Ambient)
Sensor Type	NTC10k 3m Long (Can Be Extended To 50m)
Operating Frequency	2401 - 2484MHz
Max. Radio-Frequency Power Transmitted	20dBm
Installation Depth	Recommended: 50 mm Back Box
	Minimum: 35mm Back Box
Compatibility	Electric, Hydronic Underfloor Heating. Max. 16A (3680W) Central Heating Systems (Combi & system boilers with switch live, 230V AC input)
Er-P Class	IV
Warranty	12 Years
Approvals	BEAB



**NOTE:** Hereby, Warmup plc, declares that the radio equipment type 6iE-01-XX-YY is in compliance with the RED Directive 2014/53/EU and Radio Equipment Regulations 2017. The declarations of conformity may be consulted by scanning the QR Code or visiting [www.literature.warmup.co.uk/d-o-c/6iE](http://www.literature.warmup.co.uk/d-o-c/6iE).



### Instructions for Disposal

Do not dispose of the device with regular domestic waste! Electronic equipment must be disposed of at local collection points for waste electronic equipment in compliance with the Waste Electrical and Electronic Equipment Directive.



## Warranty

---



Warmup plc warrants this product, to be free from defects in the workmanship or materials, under normal use and service, for a period of twelve (12) years from the date of purchase by the consumer when installed with a Warmup heater.

If at any time during the warranty period the product is determined to be defective, Warmup shall repair or replace it, at Warmup's option. If the product is defective, please either;

Return it, with a bill of sale or other dated proof of purchase, to the place from which you purchased it, or

Contact Warmup. Warmup will determine whether the product should be returned or replaced.





















The twelve (12) year warranty only applies if the product is registered with Warmup within 30 days after purchase. Registration can be completed online at [www.warmup.co.uk](http://www.warmup.co.uk)

This warranty does not cover removal or re-installation costs and shall not apply if it is shown by Warmup that the defect or malfunction was caused by failure to follow the instruction manuals, incorrect installation or damage which occurred while the product was in the possession of a consumer. Warmup's sole responsibility shall be to repair or replace the product within the terms stated above. If the 6iE is installed with a non-Warmup heater a three (3) year warranty will apply. This warranty does not extend to any associated software such as apps or portals.

WARMUP SHALL NOT BE LIABLE FOR ANY LOSS OR DAMAGE OF ANY KIND, INCLUDING ANY INCIDENTAL OR CONSEQUENTIAL DAMAGES RESULTING, DIRECTLY OR INDIRECTLY, FROM ANY BREACH OF ANY WARRANTY, EXPRESS OR IMPLIED, OR ANY OTHER FAILURE OF THIS PRODUCT. THIS WARRANTY IS THE ONLY EXPRESS WARRANTY WARMUP MAKES ON THIS PRODUCT. THE DURATION OF ANY IMPLIED WARRANTIES, INCLUDING THE WARRANTIES OF MERCHANTABILITY AND FITNESS FOR A PARTICULAR PURPOSE, IS HEREBY LIMITED TO THE TWELVE-YEAR DURATION OF THIS WARRANTY.

This Warranty does not affect your statutory rights.

## Appendix 1.0 - Thermostat use cases

No.	Reg. Mode	Probe P1 (5 & 6)	Probe P2 (6 & 7)	Control	Limit Sensor	Use Case
1	OFF	OFF	OFF	Internal Air Sensor	None	  Thermostat in room air temperature schedule no floor limit
2		ON	OFF	P1 Floor Sensor	None	 Thermostat in/out of room floor temperature schedule floor limit
3					Internal Air Sensor	  Thermostat in room floor temperature schedule air limit
4				P1 Air Sensor	None	  Thermostat out of room air temperature schedule no floor limit
5		OFF	ON	Internal Air Sensor	P2 Floor Limit	  Thermostat in room air temperature schedule floor limit
6		ON	ON	P1 Floor Sensor	P2 Floor Limit	 Thermostat in/out of room floor temperature schedule floor limit
7				P1 Air Sensor	P2 Floor Limit	  Thermostat out of room air temperature schedule floor limit
8	ON	OFF	OFF	Reg.	None	   Thermostat in/out of room regulator schedule no limit
9					Internal Air Sensor	   Thermostat in room regulator schedule air limit
10		OFF	ON	Reg.	P2 Floor Limit	  Thermostat in/out of room regulator schedule floor limit

 Conventional     Electric underfloor heating     Hydronic underfloor heating

# Warmup®



**Warmup plc**

[www.warmup.co.uk](http://www.warmup.co.uk)

[uk@warmup.com](mailto:uk@warmup.com)

**T:** 0345 345 2288

**F:** 0345 345 2299

**Warmup plc** ■ 704 Tudor Estate ■ Abbey Road ■ London ■ NW10 7UW ■ UK  
**Warmup GmbH** ■ Ottostraße 3 ■ 27793 Wildeshausen ■ DE